

ENCLOSURE EXPLOSION PROOF

NEPSI PROOF No. GYJ06235 Ex d IIC T3~T6

PTB PROOF No. 05 ATEX 1025 Ex II 2G EEx d IIB T3~T6

Ex II 2D IP65 T3~T6

Order No. FF

Connecting Type
(Refer to page 14)

Float Type

7 : Explosion Proof (EX d IIB T4)

Order No. FF 70 CEQ
Model No. LF 70 CEQ

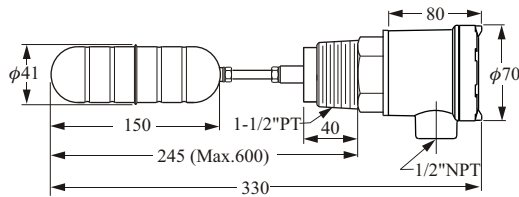

Order No. FF 70 DFQ
Model No. LF 70 DFQ

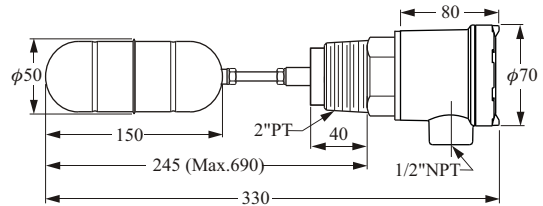

Order No. FF 71 BHM
Model No. LF 71 BHM

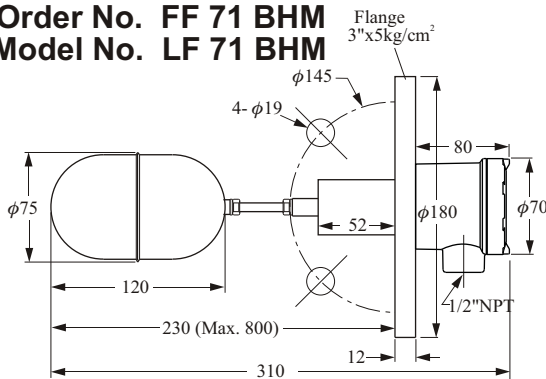

Order No. FF 71 CEM
Model No. LF 71 CEM

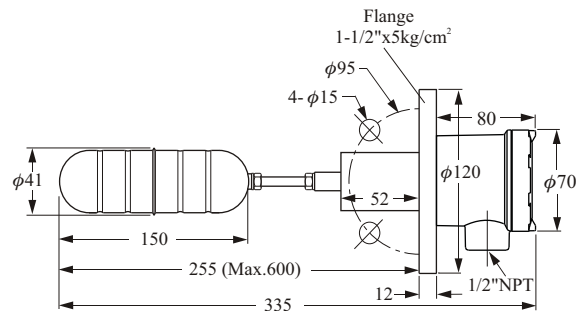

Order No. FF 71 DFM
Model No. LF 71 DFM

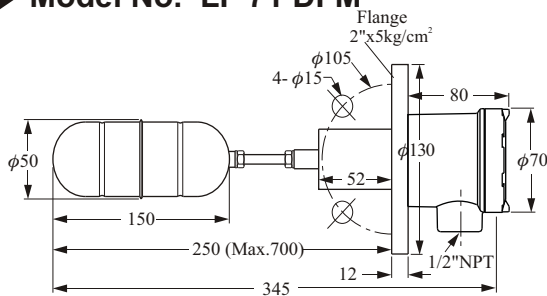

Order No. FF 73 CLO
Model No. LF 73 CLO

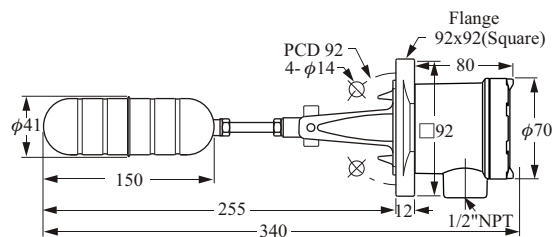

Order No. FF 74 DFM
Model No. LF 74 DFM

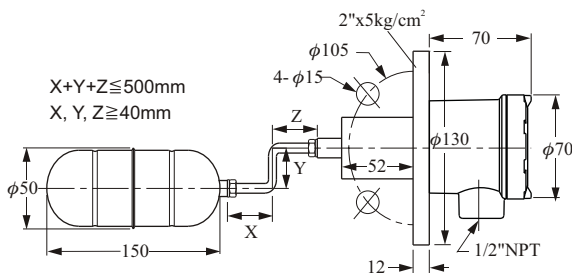

Order No. FF 75 DFM
Model No. LF 75 DFM

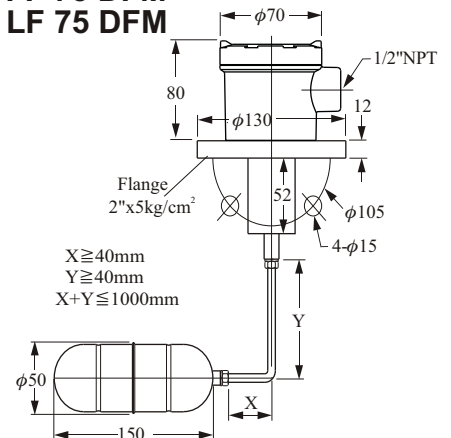

HOW TO MAKE YOUR ORDER

Order No. **FF** **70** **C** **E** **M** **S** **T**
 Model No. **LF** **70** **C** **E** **M** **S** **T**

ORDER NO. _____

- 70: LF70 ENCLOSURE EXPLOSION PROOF (Ex d IIC T3~T6)
- 71: LF71 ENCLOSURE EXPLOSION PROOF (Ex d IIC T3~T6)
- 73: LF73 ENCLOSURE EXPLOSION PROOF (Ex d IIC T3~T6)
- 74: LF74 ENCLOSURE EXPLOSION PROOF (Ex d IIC T3~T6)
- 75: LF75 ENCLOSURE EXPLOSION PROOF (Ex d IIC T3~T6)

FLOAT TYPE _____

- B: $\phi 75 \times 120$ (OPERATION PRESSURE 10 kg/cm^2 S.G. 0.25)
- C: $\phi 41 \times 150$ (OPERATION PRESSURE 15 kg/cm^2 S.G. 0.65)
- D: $\phi 50 \times 150$ (OPERATION PRESSURE 30 kg/cm^2 S.G. 0.55)
- G: $\phi 41 \times 125$ (OPERATION PRESSURE 15 kg/cm^2 S.G. 0.7)
- H: $\phi 41 \times 100$ (OPERATION PRESSURE 15 kg/cm^2 S.G. 0.8)

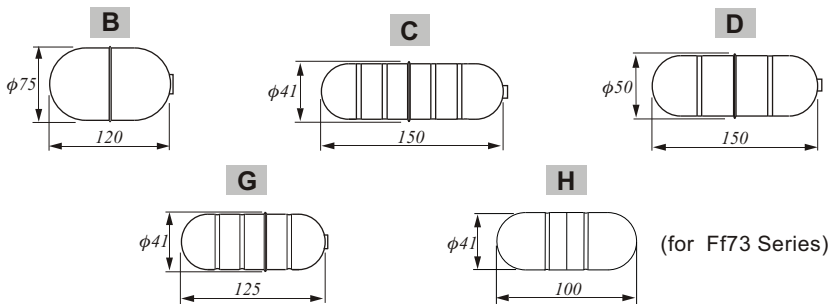

CONNECTING TYPE _____

- | | | |
|-----------------|-------------------------|-----------------|
| E: 1-1/2" (40A) | M: 5 kg/cm^2 | W: PN10 (10Bar) |
| F: 2" (50A) | N: 10 kg/cm^2 | X: PN16 (16Bar) |
| G: 2-1/2" (65A) | O: 150 Lbs | Y: PN25 (25Bar) |
| H: 3" (80A) | P: 300 Lbs | Z: PN40 (40Bar) |
| I: 4" (100A) | Q: PT | S: Others |
| J: 5" (125A) | R: PF(G) | |
| K: 6" (150A) | T: BSP | |
| L: 92x92 | U: NPT | |

CUSTOM LENGTH(L) (UNIT: mm) _____

TEST ACCESSORY _____

- ※ Tolerance of the total product length is $\pm 5 \text{ mm}$
- ※ Characteristics, specifications and dimensions are subject to change without notice.
- ※ Please contact your nearest distributor office for further information.