



APPLICATIONS
ENGINEERING LTD

<http://www.appeng.co.uk>
email: info@appeng.co.uk

16 HORSTED SQUARE, BELLBROOK INDUSTRIAL ESTATE,
UCKFIELD, EAST SUSSEX, TN22 1QG, UK

TEL: + 44 1825 764737
FAX: + 44 1825 768330

LS-240, LS-270 & LS-750 Bilge water level switches

The design of these bilge water level switches combines reliable switching in contaminated liquids with compact dimensions. These switches have been developed for general naval and industrial applications. They have protective housings which dampen the movements and turbulence of the medium and maintain their reliable operation even if there is solid matter in the bilge water.

Acceptance and Approvals

Various civil, military and naval approvals are on hand for many of these products. Please ask for further details.

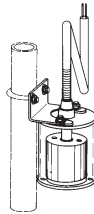
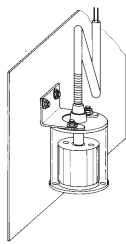

ABS
American Bureau
of Shipping



LS-240-3E



Germanischer Lloyd
GL (Germany)



LS-270-E



Germanischer Lloyd
GL (Germany)



LS-750

Applications

LS-240-3E: This switch has extremely robust construction. It is perfectly suitable for applications on ships and wherever heavy mechanical loads occur. The LS-240-3E has been accepted by the Germanischer Lloyd, among others, and approved for application by the German Navy.

LS-270-E: This bilge water level switch has been developed especially for low level alarms and can monitor levels as low as 35 mm. As the cable is vulcanized the switch is submersible to "IP67". The float can also be constructed as an interface level indicator. The LS-270-E has been accepted by the Germanischer Lloyd, among others, and approved for application by the German Navy.

LS-750: With a compact-sized float, slosh shield and weighted collar, the LS-750 provides liquid level detection for a wide variety of applications. Suspend in stand pipes or sumps for leak detection duty, or drop into wells for ground-water monitoring. Supplied with 7.5m of waterproof cable.

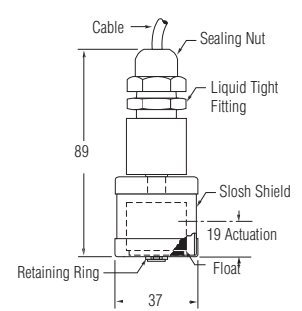
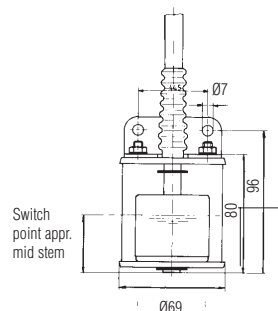
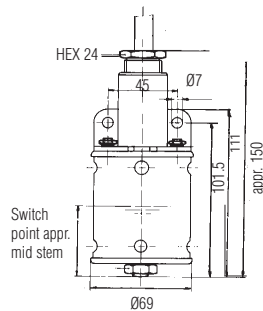
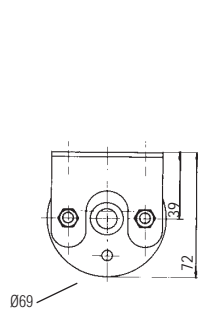

Specifications

	LS-240-3E	LS-270-E	LS-750
Material stem	S Steel	S Steel	Brass
Material float:	Buna N	Buna N	Buna N
Stilling chamber	S. Steel	Lucite	Brass
Bracket	S Steel	S Steel	
Operating pressure	10 bar	10 bar	10 bar
Temperature -40°C to	+80°C	+80°C	+80°C Water
Min. specific gravity of the liquid	0.53	Standard: 0.58 Interface level: 0.85/1	0.45
Protection rating	IP67	IP67	IP68 to 8m
Type of reed switch	SPST 100 VA	SPST 100 VA	N.C., 20VA
Electrical connection	(Length 2m) Cable: LMGSGo 2 x 1.5mm ²	(Length 2m) Cable: CR 3x1.5mm ²	(Length 7.5m) PVC Cable Jacket 22 AWG
Weight	650 g	530 g	830 g

How to Order

STD Float	010-3433 NO.	010-3434 NC	010-0349 NO	010-0350 NC	149350 NC
Interface Float Oil/Water			010-0351 NO	010-0352 NC	

Connecting Diagram

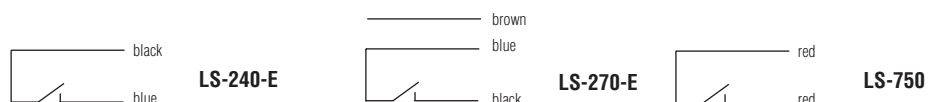

Standard Products in **bold**