

620

Overpressure and vacuum switch

– 900 mbar ... 6 bar

625

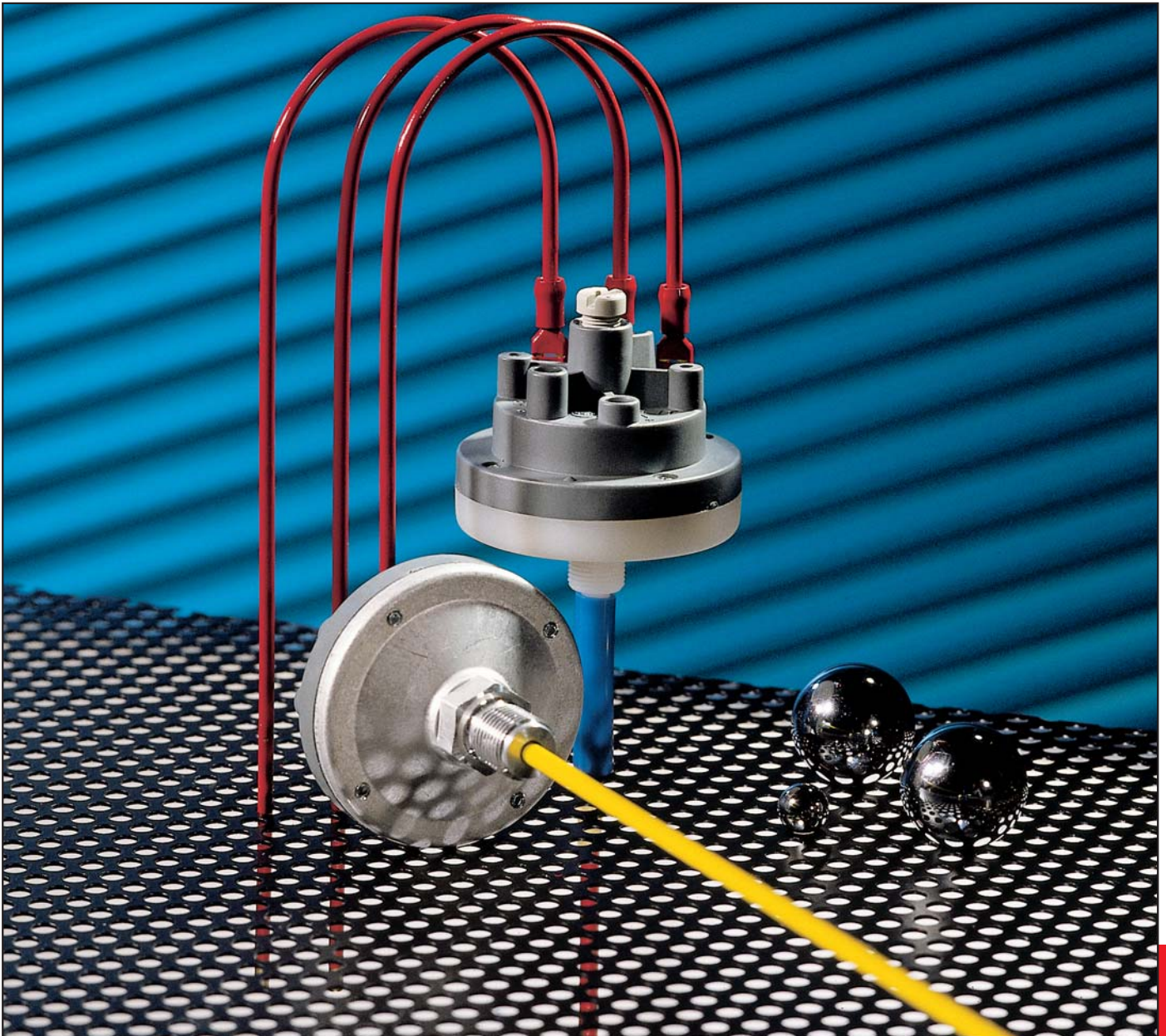

EDITION 03/2005

HUBA-REGISTERED TRADE MARK



Technical overview

With their finely tuned range increments and long-term switching point stability, overpressure and vacuum switches of type 620/25 are suitable for monitoring liquids and gases in industrial equipment manufacturing applications in general, in process technology or in food automation.

The rugged mechanics are the assurance of high operating reliability, even in the presence of percussions or vibrations. A range of switches with many standard versions and ideal price/performance ratio, even in the case of small quantities.

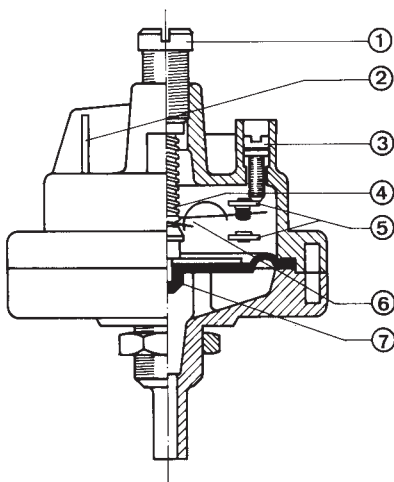

Legend to cross-section drawing

- 1 Switching point setting
- 2 AMP tab connectors
- 3 Switching difference setting
- 4 Compression spring
- 5 Changeover contact
- 6 Contact element
- 7 Diaphragm

The distinct advantages

- High accuracy by 13 ideally designed pressure range increments
- Switching differences adjustable
- High long-term stability with reproducibility of switching points up to $< \pm 0.3$ mbar
- Customer-specific switching points adjustable in factory
- Rugged industrial switch with excellent price/performance ratio

Pressure ranges

See order code selection table

Maximum overpressure

Maximum overpressure and test pressure see setting ranges

Setting ranges

See graphic on the back

Lowest turn-on pressure

2 mbar
Switching point and switching difference adjustable

Smallest switching difference: 1 mbar

Repeatability

$\pm 5\%$ of the switching point of type A, F diaphragm material, but as a minimum ± 0.3 mbar

$\pm 10\%$ of the switching point of type C, E diaphragm material, but as a minimum ± 0.6 mbar

Temperature range

Medium temperature with diaphragm type 625:
 NBR-based 0 ... + 80 °C
 FPM - 10 ... + 80 °C
 EPDM - 10 ... + 80 °C
 Q (Silicon) - 40 ... + 80 °C

Ambient temperature T 65

Type 620 see order code selection table

Case construction

Type series 620/25: Switch case fiberglass-reinforced

Type series 620: Base ABS or PA

Type series 625: Base aluminium or brass. Other specifications or surface treatment on request

Weight

Type 620 70 g
 Type 625 with aluminium base 100 g
 Type 625 with base brass 200 g

Installation arrangement

Unrestricted. For switching points calibrated in the factory indicate installation arrangement.

Pressure connections

Type 620

Connection pipe \varnothing 6 mm, inside thread M5, thread M12x1 with counter nut

Type 625

Thread G 1/8, G 1/4, M12x1 with counter nut.

See order code selection table. Other threads on request

Diaphragm

A NBR-based C FPM
 E EPDM F Silicon

Parts coming into contact with the medium, to base and diaphragm. Polyacetal and stainless steel 1.4301 with vacuum switch version.

Electrical connections

Screw terminals (option), AMP tab connectors 6.3 mm, cable gland PG 11 with cover

Contact system

Changeover contact

Contact material / Loading

Nominal voltage, type of current	250 VAC	250 VAC
Nominal current for resistive loading	1 A	6 A
Nominal voltage for motor loading	0.5 A	3 A
Contact material	AgCdO	AgCdO

Type of protection

Without cover	IP 00
With cover (for installation arrangement electrical connections upward)	IP 54

Service life

Mechanical and electrical service life: 10^6 switching cycles, if the permitted switching difference is respected according to the diagram on the back.

Accessories

See order code selection table

Versions



Plastic cover with Pg 11 on side



Screw terminals
AMP connector set



Mounting bracket



Type 620 with pressure case
ABS / PA



Type 625 with pressure case
alu/brass

Order code selection table

620. X X X X

Pressure ranges ¹ (mbar)	2 ... 8	p max 30	pt ² 50	Switching capacity 250 V				
					1 A	2	3	4
	6 ... 75	300	500	1 A				
	12.5 ... 80	300	500	6 A				
	12.5 ... 200	300	500	1 A				
	25 ... 220	300	500	6 A				
Pressure connections/ Pressure case	Hose	∅ 6 mm	(M12x1) ABS	... 70 °C				0
	Hose	∅ 6 mm	(M12x1) PA 66	... 80 °C				1
	Inside thread	M5	(M12x1) ABS	... 70 °C				2
	Inside thread	M5	(M12x1) PA 66	... 80 °C				3
Diaphragm material	Type A – NBR-based							0
	Type C – FPM							2
	Type E – EPDM							4
	Type F – Q (Silicon)							6

Order code selection table

625. X X X X

Pressure Vacuum								
					9			
					6			
Pressure ranges ¹ (mbar)	2 ... 8	p max 30	pt ² 50	Switching capacity 250 V				
	6 ... 75	300	500	1 A				0
	12.5 ... 80	300	500	6 A				1
	12.5 ... 200	300	500	1 A				2
	25 ... 220	300	500	6 A				3
	80 ... 2000	6000	10 000	1 A				4
	120 ... 2200	6000	10 000	6 A				5
	1000 ... 6000	6000	10 000	6 A				6
Vacuum ranges ¹	-4 ... -30	-50	-100	1 A				7
	-15 ... -80	-300	-500	1 A				1
	-30 ... -150	-300	-500	6 A				2
	-50 ... -600	-1000	-1000	6 A				3
	-100 ... -900	-1000	-1000	6 A				4
Pressure connections/ Pressure case	G 1/8	Aluminium						5
	M12x1	Aluminium						1
	G 1/4	Brass						2
	G 1/4	Aluminium						3
	G 1/4	Nickel-plated brass 5 µm						4
	G 1/8	Brass						A
Diaphragm material	Type A – NBR-based							B
	Type C – FPM							2
	Type E – EPDM							4
	Type F – Q (Silicon)							6

Accessories

Plastic cover with Pg 11 lateral	IP 54			1	0	5	8	3	6
Mounting bracket with hole	∅ 12.5 mm	for M12		1	0	4	2	5	9
Mounting bracket with hole	∅ 14 mm	for G 1/4		1	0	2	8	7	2
AMP Stecker-Set				1	0	3	4	7	9
Schraubklemmen-Set				1	0	3	4	9	1

¹ Other pressure ranges on request

² pt = test pressure

2 ... 8 mbar

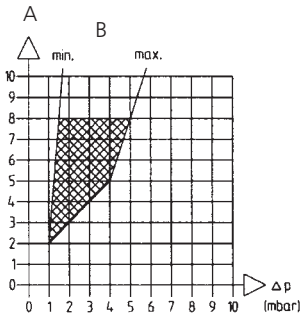

6 ... 75 mbar

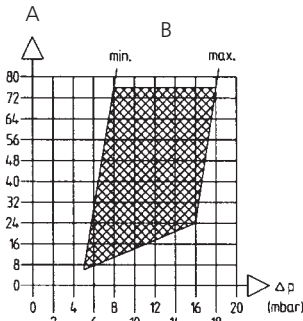

12.5 ... 80 mbar

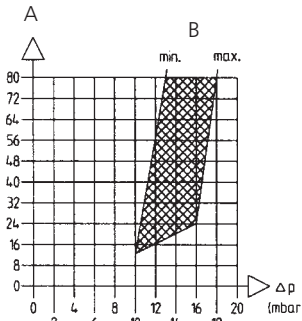

12.5 ... 200 mbar

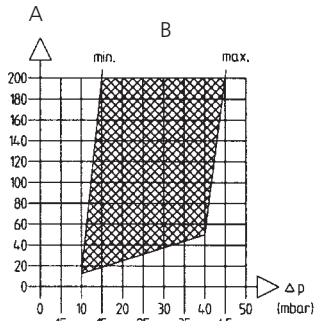

25 ... 220 mbar

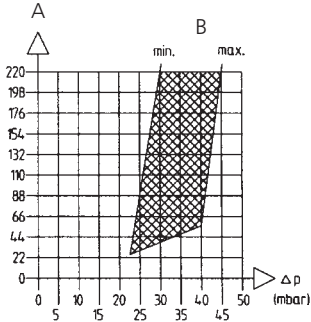

80 ... 2000 mbar

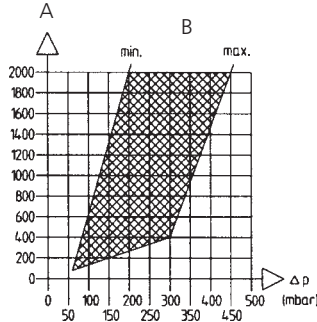

120 ... 2200 mbar

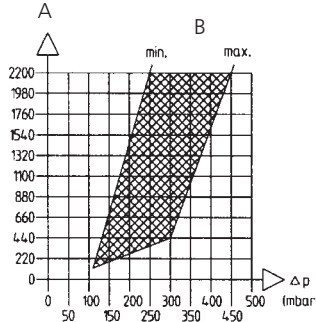

1000 ... 6000 mbar

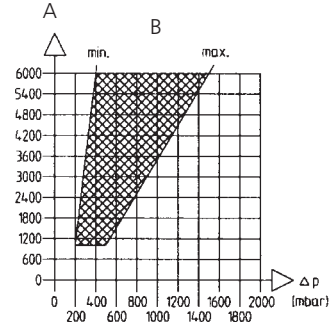

-4 ... -30 mbar

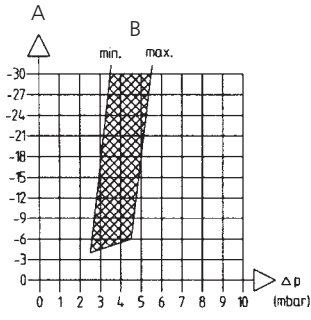

-15 ... -80 mbar

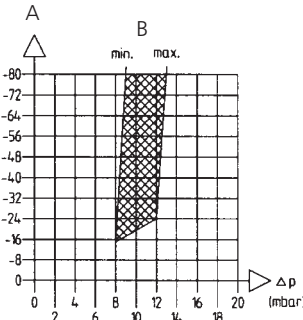

-30 ... -150 mbar

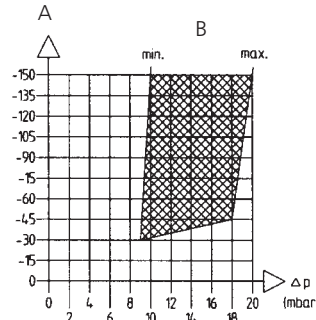

-50 ... -600 mbar

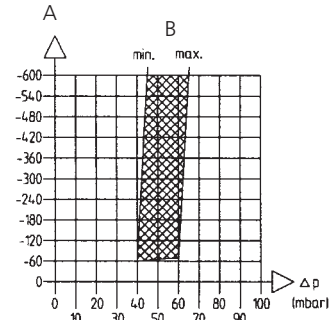

A Upper switching point (mbar) B Distance between contacts

-100 ... -900 mbar

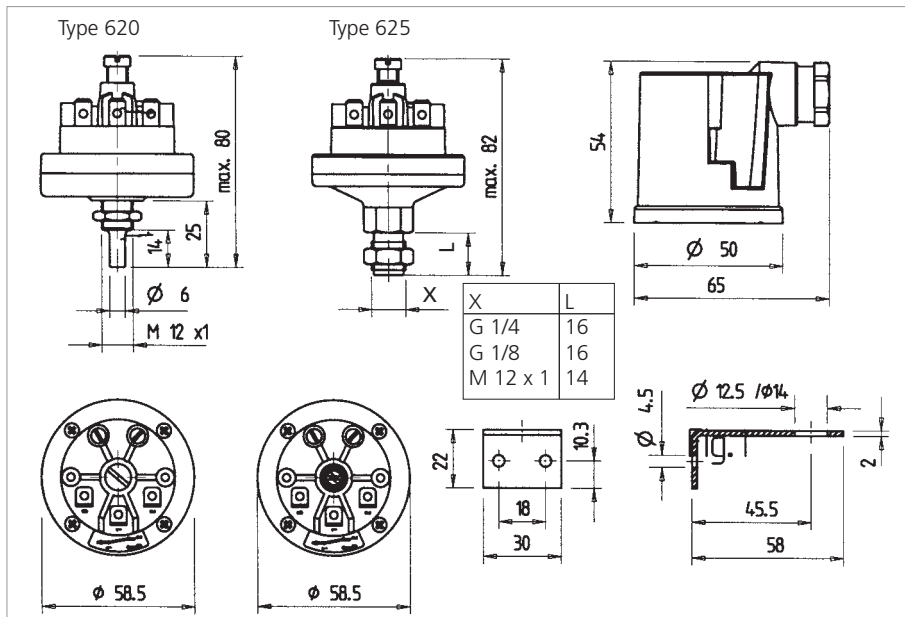
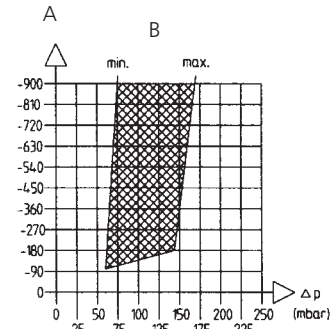

- 1 Common
- 2 NC contact
- 3 NO contact

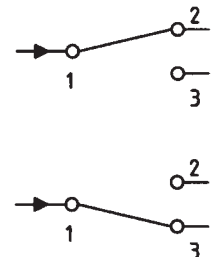

For vacuum:
terminal 3 break contact